

Power Operational Amplifiers

FEATURES

- ◆ Low Cost
- ◆ Wide Common Mode Range
- ◆ Standard Supply Voltage
 - ◆ Single Supply: 10V to 50V
- ◆ Output Current - 150mA Continuous
- ◆ Output Voltage 50-350V
- ◆ 350 V/ μ S Slew Rate
- ◆ 200 kHz Power Bandwidth

Applications

- ◆ Piezoelectric positioning and Actuation
- ◆ Electrostatic Deflection
- ◆ Deformable Mirror Actuators
- ◆ Chemical and Biological Stimulators

GENERAL DESCRIPTION

The MP400FC combines a high voltage, high speed precision power op amp with a supply voltage boost function in an integrated thermally conductive module. The voltage boost function uses a switch mode power supply (SMPS) to boost the input power supply voltage. This allows the user the benefits of using his standard 12V or 24V buss without the need to design a high voltage supply to power the op amp. The SMPS voltage is adjustable from 50-350V, allowing for op amp output voltages up to 340V. External phase compensation provides the user with the flexibility to tailor gain, slew rate and bandwidth for a specific application. The unique design of this amplifier provides extremely high slew rates in pulse applications while maintaining low quiescent current. The output stage is well protected with a user defined current limit. Safe Operating Area (SOA) must be observed for reliable operation.

EQUIVALENT CIRCUIT DIAGRAM

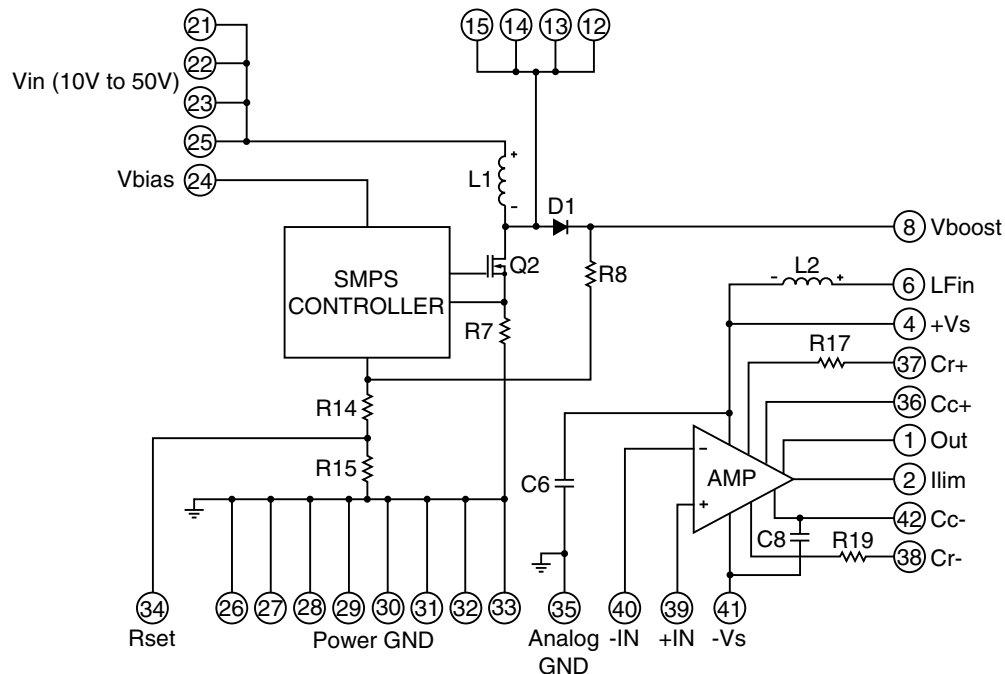

1. CHARACTERISTICS AND SPECIFICATIONS

ABSOLUTE MAXIMUM RATINGS

| Parameter | Symbol | Min | Max | Units |
|--|--------|-----|------|-------|
| SUPPLY VOLTAGE, +V _{CC} to GND | | | 50 | V |
| OUTPUT CURRENT, peak within SOA | | | 200 | mA |
| POWER DISSIPATION, internal, DC, Amplifier | | | 14.2 | W |
| OUTPUT POWER, SMPS | | | 67 | W |
| INPUT VOLTAGE, Differential | | -16 | 16 | V |
| INPUT VOLTAGE, Common Mode | | -16 | 16 | V |
| TEMPERATURE, pin solder, 10s | | | 225 | °C |
| TEMPERATURE, junction (Note 2) | | | 150 | °C |
| TEMPERATURE RANGE, storage | | -40 | 105 | °C |
| OPERATING TEMPERATURE, case | | -40 | 85 | °C |

SPECIFICATIONS

| Parameter | Test Conditions | Min | Typ | Max | Units |
|--------------------------------------|---|-----|------------------------|-----------------------|--------|
| AMPLIFIER INPUT | | | | | |
| OFFSET VOLTAGE | | | 8 | 40 | mV |
| OFFSET VOLTAGE vs. temperature | 0 to 85°C (Case) | | -63 | | μV/°C |
| OFFSET VOLTAGE vs. supply | | | | 32 | μV/V |
| BIAS CURRENT, initial (Note 3) | | | 8.5 | 200 | pA |
| OFFSET CURRENT, initial | | | 12 | 400 | pA |
| INPUT RESISTANCE, DC | | | 10 ⁶ | | Ω |
| COMMON MODE VOLTAGE RANGE, pos. | | | +V _S - 2 | | V |
| COMMON MODE VOLTAGE RANGE, neg. | | | -V _S + 5.5 | | V |
| COMMON MODE REJECTION, DC | | 90 | 118 | | dB |
| NOISE | 700KHz bandwidth | | 418 | | μV RMS |
| AMPLIFIER GAIN | | | | | |
| OPEN LOOP @ 15Hz | | 89 | 120 | | dB |
| GAIN BANDWIDTH PRODUCT @ 1MHz | | | 1 | | MHz |
| PHASE MARGIN | Full temperature range | | 50 | | ° |
| AMPLIFIER OUTPUT | | | | | |
| VOLTAGE SWING | I _O = 10mA | | V _S - 2 | | V |
| VOLTAGE SWING | I _O = 100mA | | V _S - 8.6 | V _S - 12 | V |
| VOLTAGE SWING | I _O = 150mA | | V _S - 10 | | V |
| CURRENT, continuous, DC | | 150 | | | mA |
| SLEW RATE | | 100 | 350 | | V/μS |
| SETTLING TIME, to 0.1% | 2V Step | | 1 | | μS |
| RESISTANCE, No load | R _{LIM} = 6.2Ω | | 44 | | Ω |
| POWER BANDWIDTH, 300V _{P-P} | +V _S = 160V, -V _S = -160V | | 200 | | kHz |
| CURRENT, quiescent, amplifier only | | 0.2 | 0.7 | 2.5 | mA |

SPECIFICATIONS, (cont).

| Parameter | Test Conditions | Min | Typ | Max | Units |
|----------------------------------|--|-------|------|-----|-----------|
| SMPS | | | | | |
| INPUT VOLTAGE, V_{IN} | | 10 | | 50 | V |
| SMPS OUTPUT VOLTAGE, V_B | | 46.75 | | 365 | V |
| SMPS OUTPUT CURRENT, I_S | $V_B = 10 \times V_{IN}$ | 150 | | | mA |
| OUTPUT VOLTAGE TOLERANCE | $V_B \leq 10 \times V_{IN}$, $I_S \leq 150\text{mA}$, $R_{SET} = 1\%$ | | +/-2 | 6.5 | % |
| VOLTAGE BOOST | | | 10 | | x input V |
| THERMAL | | | | | |
| RESISTANCE, DC, junction to case | Full temperature range, $f < 60\text{Hz}$ | | 7.7 | 8.8 | °C/W |
| RESISTANCE, junction to air | Full temperature range | | 46 | | °C/W |
| TEMPERATURE RANGE, case | | 0 | | 70 | °C |

NOTES:

1. (All Min/Max characteristics and specifications are guaranteed over the Specified Operating Conditions. Typical performance characteristics and specifications are derived from measurements taken at typical supply voltages and $T_C = 25^\circ\text{C}$).
2. Long term operation at the maximum junction temperature will result in reduced product life. Derate power dissipation to achieve high MTTF.
3. Doubles for every 10°C of temperature increase.
4. $+V_S$ and $-V_S$ denote the positive and negative supply voltages to the output stage.

EXTERNAL CONNECTIONS

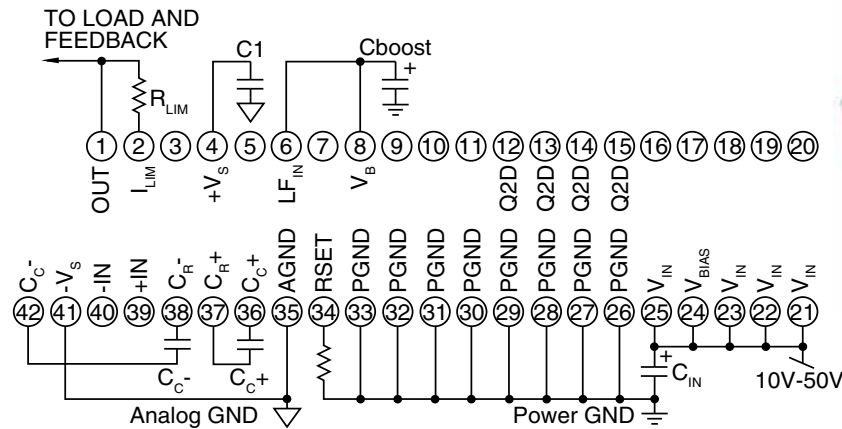

**42-Pin DIP
Package Style FC**

PIN DESCRIPTIONS

| Pin # | Pin name | Description |
|-------------|-------------------|--|
| 21 - 23, 25 | V _{IN} | Input voltage pins for the on board high voltage switch mode power supply. |
| 24 | V _{BIAS} | Input voltage pin for the boost controller circuitry. This pin is typically tied to V _{IN} . |
| 12 – 15 | Q2D | Drain node of the SMPS MOSFET switch. An external RC snubber may be connect from this node to power ground to reduce or eliminate overshoot and ringing at switch turn off, reducing switching noise on the SMPS. |
| 8 | V _B | This is the output of the high voltage SMPS and typically is tied to pin 6, L _{FIN} . Other loads can be added to this pin as long as the maximum output power of the SMPS is not exceeded. For proper operation, an external high voltage, low ESR capacitor must be connected to this pin. Refer to the paragraph titled “SMPS Output Capacitor”. |
| 6 | L _{FIN} | The high voltage SMPS, V _B , is connected to this pin to power the MP400FC amplifier through a 47uH filter inductor. The supply current in to this pin can not exceed 200mA. |
| 4 | +V _S | MP400FC amplifier high voltage supply pin. This pin is used for external supply bypass. A high quality ceramic capacitor of at least 1uF should be used. The high voltage SMPS, V _B , can be connected directly to this pin, bypassing the 47uH filter inductor. |
| 34 | RSET | SMPS voltage set resistor. A resistor is connected from this pin to power ground to set the SMPS voltage. |
| 26 – 33 | PGND | Power ground. SMPS switching circuits are referenced to ground through these pins. |
| 35 | AGND | Analog ground for MP400FC amplifier circuits. AGND and PGND are connected at one point on the MP400FC. Avoid external connections between AGND and PGND. |
| 41 | -Vs | This pin is typically connected to AGND. However, an external negative supply voltage can be connected to this pin. |
| 39 | +IN | Amplifier non-inverting input |
| 40 | -IN | Amplifier inverting input |
| 1 | V _{OUT} | Amplifier output |
| 2 | I _{LIM} | Amplifier current limit. A current limit resistor must be connected between I _{LIM} and V _{OUT} . $R_{LIM} = 0.7/I_{LIM}$. |
| 36 | CR+ | + side compensation capacitor connection one. |
| 37 | CC+ | + side compensation capacitor connection two. |
| 38 | CR- | - side compensation capacitor connection one. |
| 42 | CC- | - side compensation capacitor connection two. |

Unused pins should be left open. This is mandatory for pins 3, 5, 7, 9, 11 and 16.

TYPICAL APPLICATION

The MP400FC is ideally suited to driving both piezo actuation and deflection applications off of a single low voltage supply. The circuit above boosts a system 24V buss to 350V to drive an ink jet print head. The MP400FCs high speed deflection amplifier is biased for single supply operation by external resistors R2 – R6, so that a 0 to 5V DAC can be used as the input to the amplifier to drive the print head from 0 to >300V.

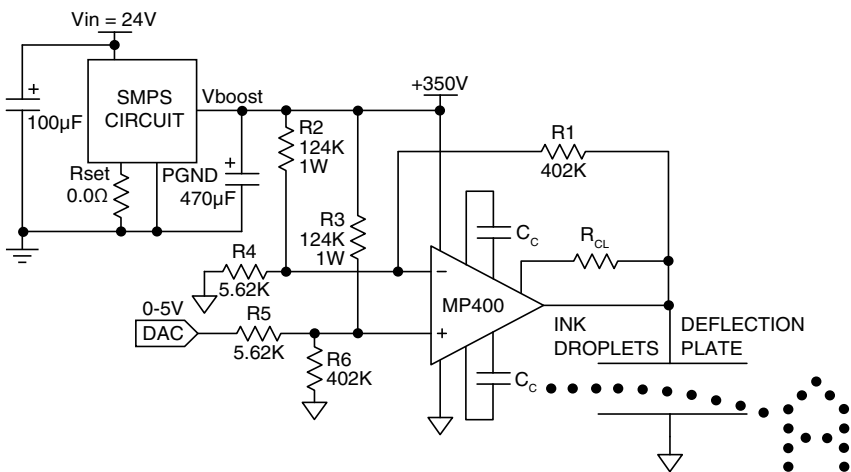

TYPICAL PERFORMANCE GRAPHS

POWER RESPONSE

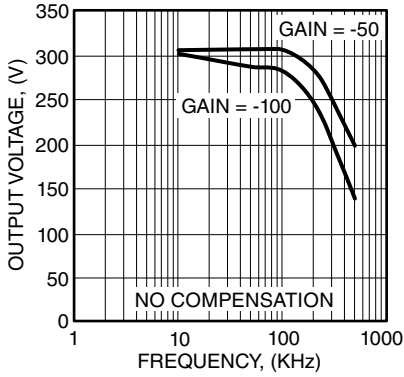

CURRENT LIMIT

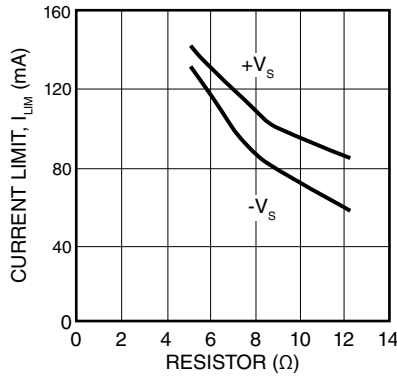

POWER SUPPLY REJECTION

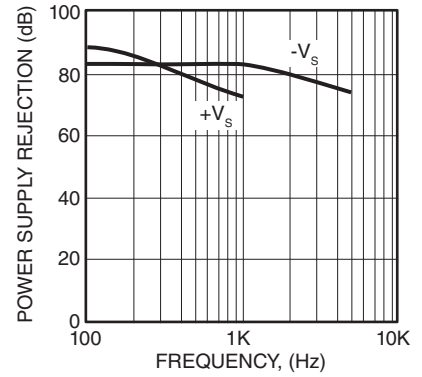

AMPLIFIER INTERNAL POWER DERATING

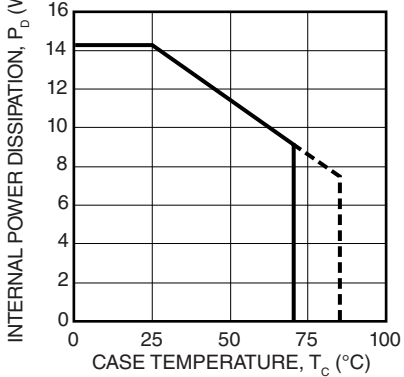

OUTPUT VOLTAGE SWING

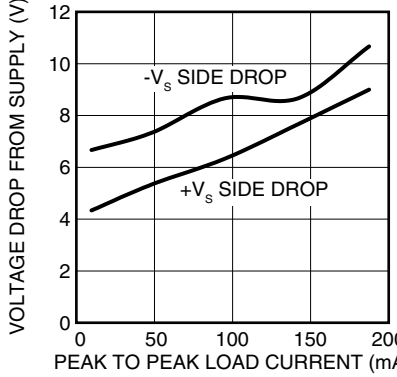

COMMON MODE REJECTION

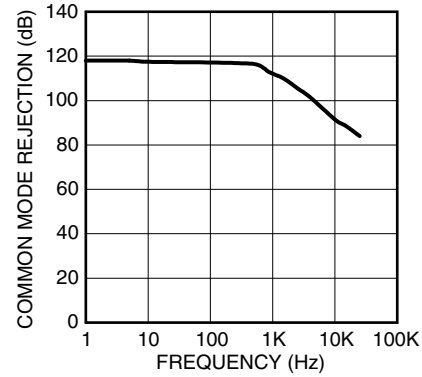

EFFICIENCY Vs. SMPS CURRENT

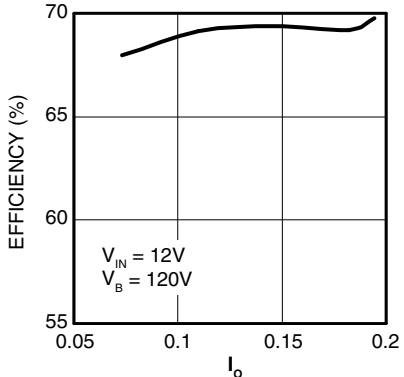

EFFICIENCY Vs. SMPS CURRENT

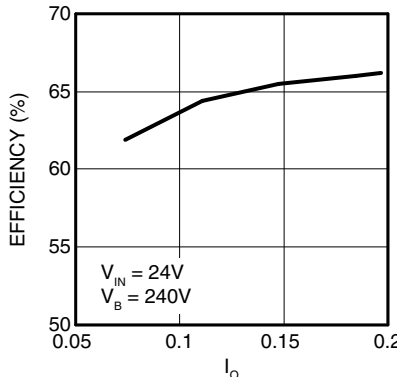

EFFICIENCY Vs. SMPS CURRENT

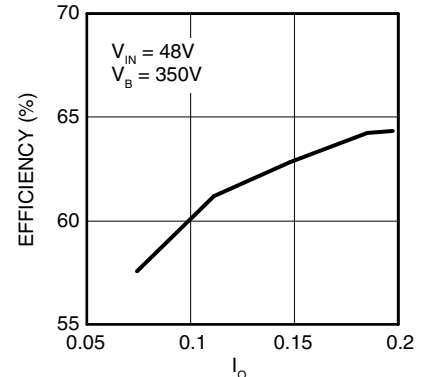

SMPS CURRENT VS. SMPS VOLTAGE

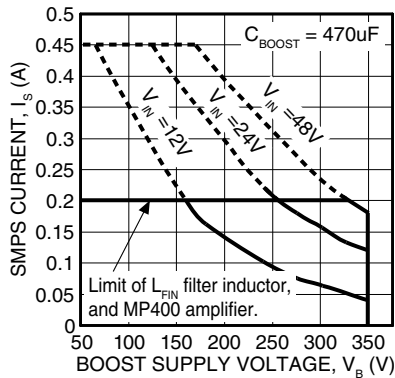

SMPS POWER DERATING

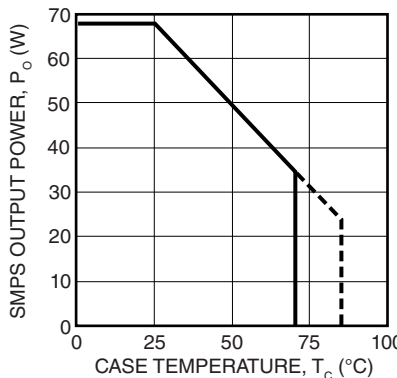

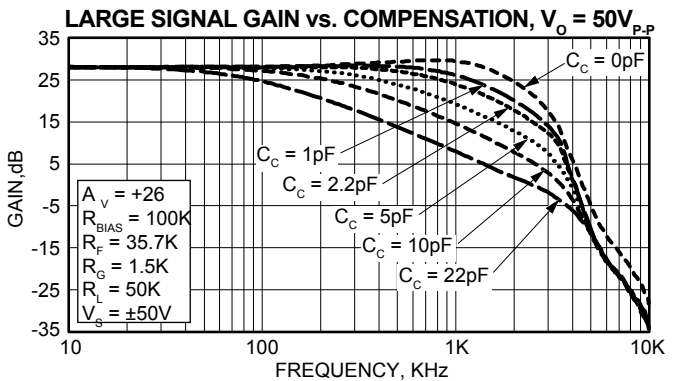
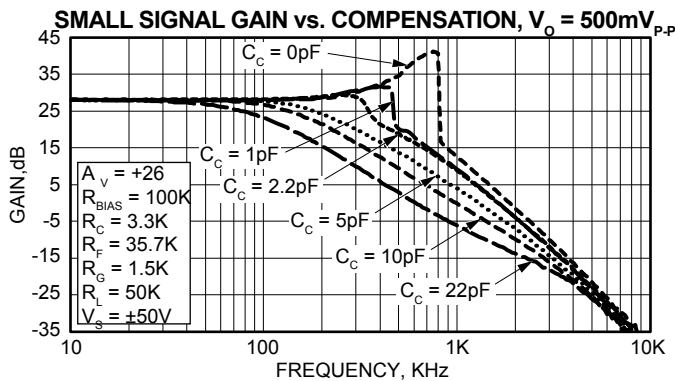
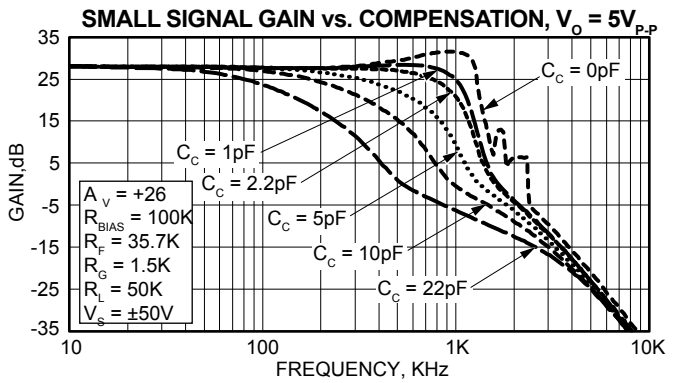
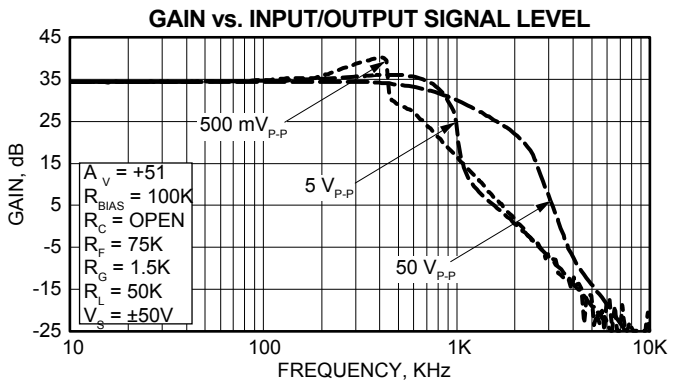
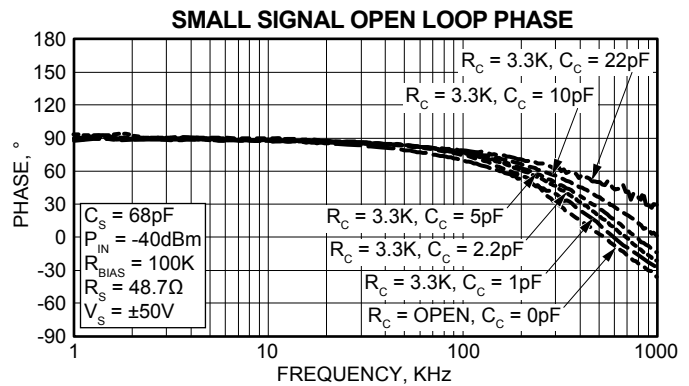
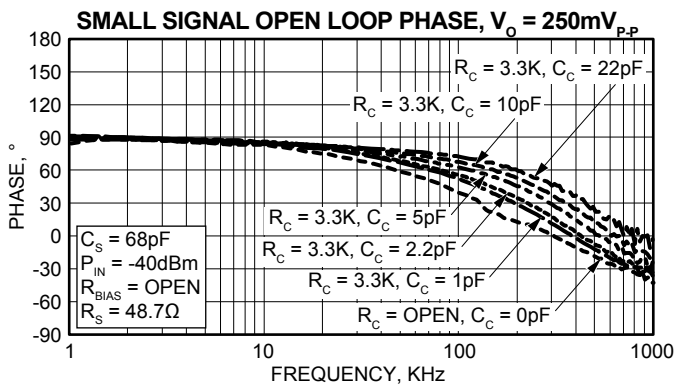
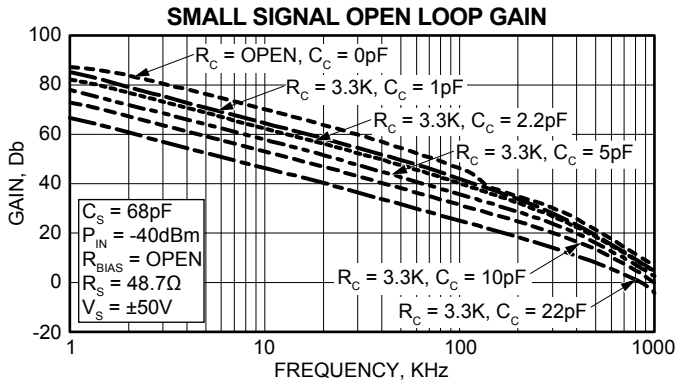

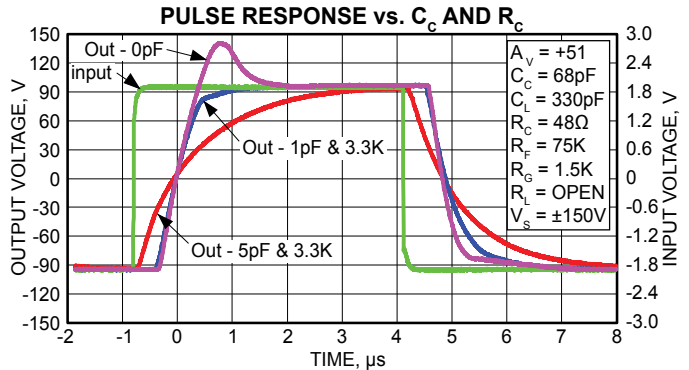
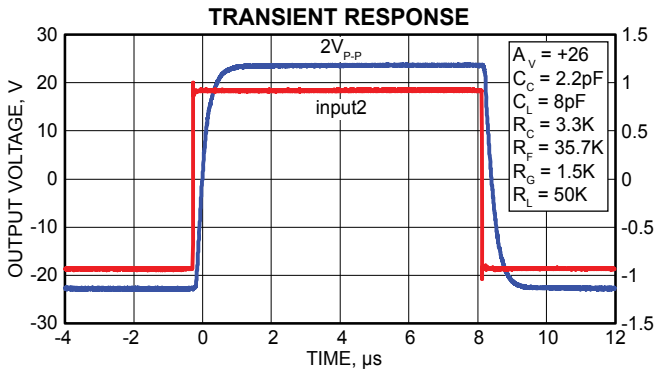
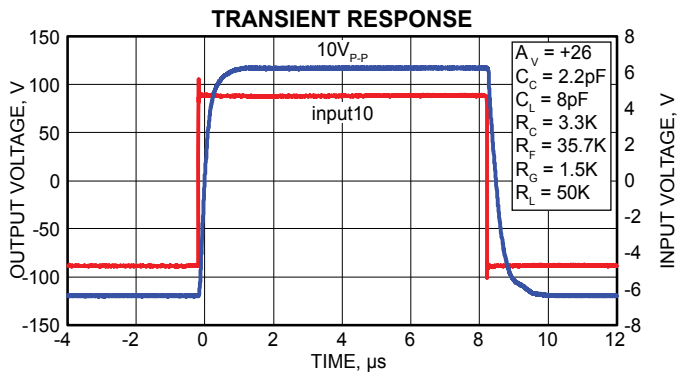
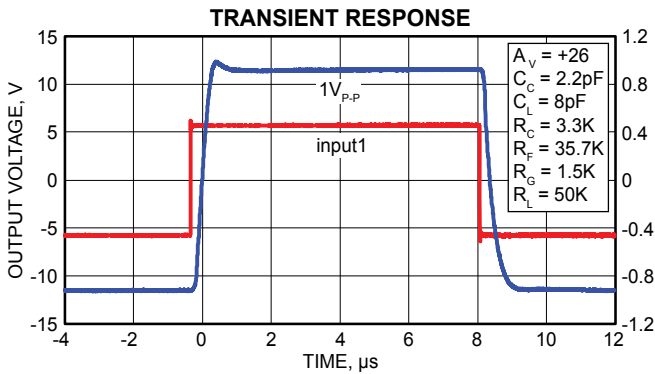
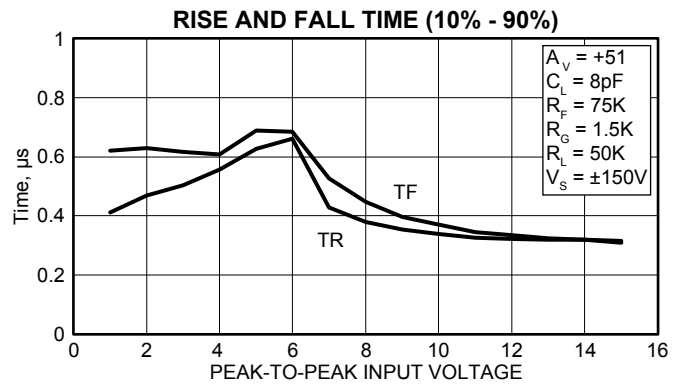
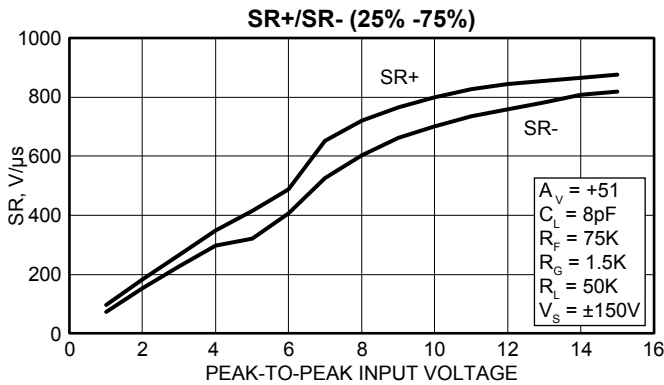
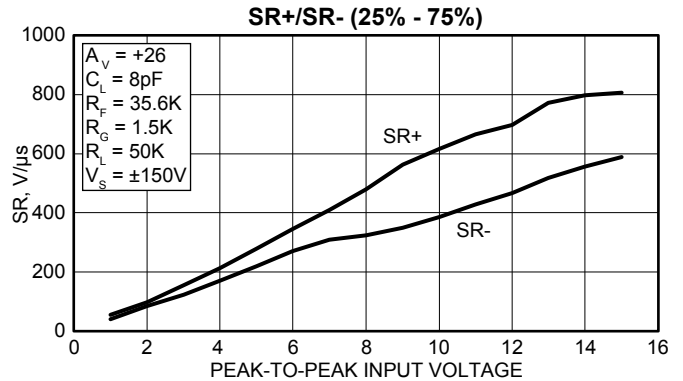
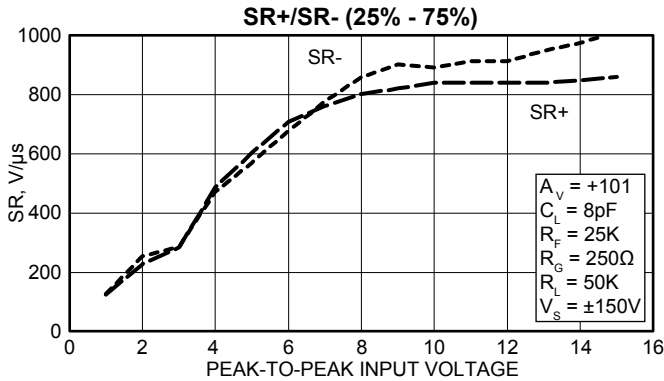

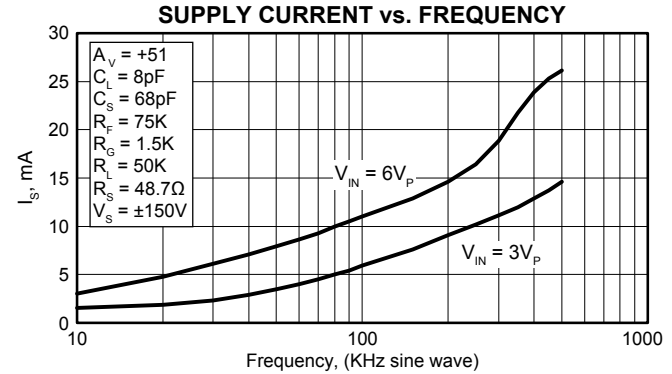
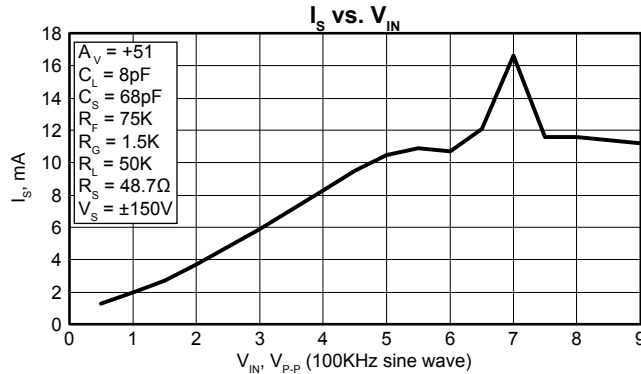
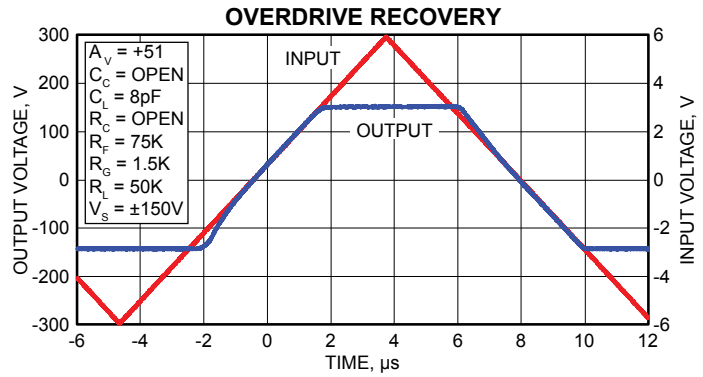
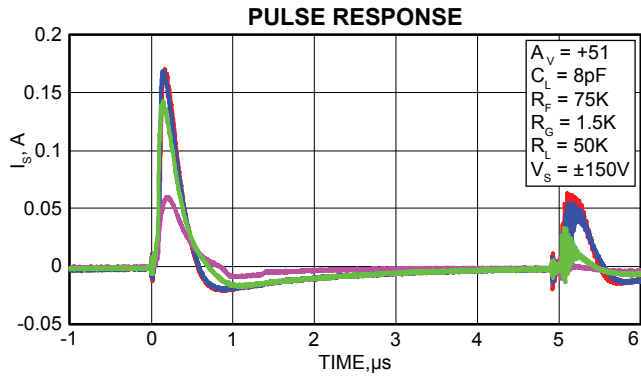
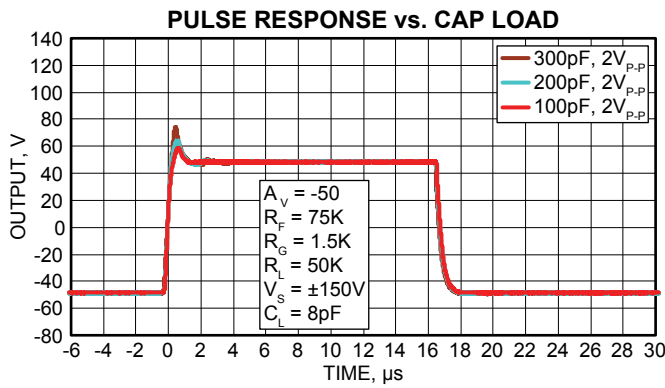
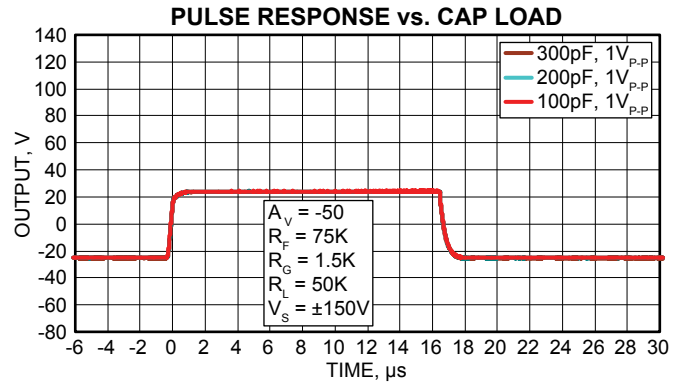
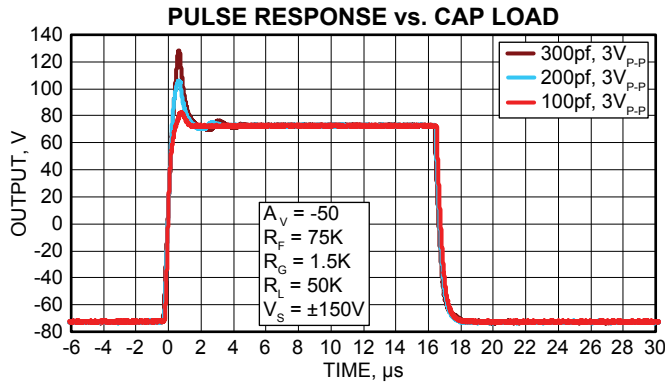

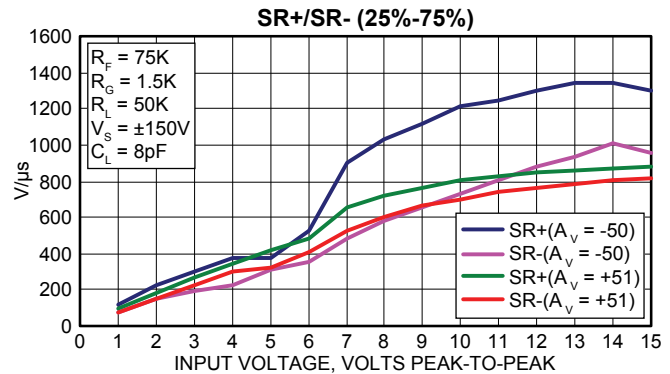
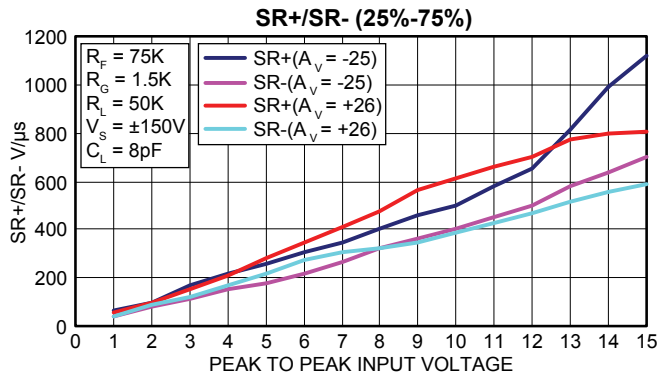

GENERAL

Please read Application note 1 “General operating considerations” which covers stability, power supplies, heat sinking, mounting, current limit, SOA interpretation, and specification interpretation. Visit www.cirrus.com for design tools that help automate tasks such as calculations for stability, internal power dissipation, and current limit. There you will also find a complete application notes library, technical seminar workbook, and evaluation kits.

THEORY OF OPERATION

The PA78 is designed specifically as a high speed pulse amplifier. In order to achieve high slew rates with low idle current, the internal design is quite different from traditional voltage feedback amplifiers. Basic op amp behaviors like high input impedance and high open loop gain still apply. But there are some notable differences, such as signal dependent supply current, bandwidth and output impedance, among others. The impact of these differences varies depending on application performance requirements and circumstances. These different behaviors are ideal for some applications but can make designs more challenging in other circumstances.

SUPPLY CURRENT AND BYPASS CAPACITANCE

A traditional voltage feedback amplifier relies on fixed current sources in each stage to drive the parasitic capacitances of the next stage. These currents combine to define the idle or quiescent current of the amplifier. By design, these fixed currents are often the limiting parameter for slew rate and bandwidth of the amplifier. Amplifiers which are high voltage and have fast slew rates typically have high idle currents and dissipate notable power with no signal applied to the load. At the heart of the PA78 design is a signal dependent current source which strikes a new balance between supply current and dynamic performance. With small input signals, the supply current of the PA78 is very low, idling at less than 1 mA. With large transient input signals, the supply currents increase dramatically to allow the amplifier stages to respond quickly. The Pulse Response plot in the typical performance section of this datasheet describes the dynamic nature of the supply current with various input transients.

Choosing proper bypass capacitance requires careful consideration of the dynamic supply currents. High frequency ceramic capacitors of 0.1uF or more should be placed as close as possible to the amplifier supply pins. The inductance of the routing from the supply pins to these ceramic capacitors will limit the supply of peak current during transients, thus reducing the slew rate of the PA78. The high frequency capacitance should be supplemented by additional bypass capacitance not more than a few centimeters from the amplifier. This additional bypass can be a slower capacitor technology, such as electrolytic, and is necessary to keep the supplies stable during sustained output currents. Generally, a few microfarad is sufficient.

SMALL SIGNAL PERFORMANCE

The small signal performance plots in the typical performance section of this datasheet describe the behavior when the dynamic current sources described previously are near the idle state. The selection of compensation capacitor directly affects the open loop gain and phase performance.

Depending on the configuration of the amplifier, these plots show that the phase margin can diminish to very low levels when left uncompensated. This is due to the amount of bias current in the input stage when the part is in standby. An increase in the idle current in the output stage of the amplifier will improve phase margin for small signals although will increase the overall supply current.

Current can be injected into the output stage by adding a resistor, R_{bias} , between $Cc-$ and $VS+$. The size of R_{bias} will depend upon the application but $500\mu A$ ($50V V+$ supply/ $100K$) of added bias current shows significant improvement in the small signal phase plots. Adding this resistor has little to no impact on small signal gain or large signal performance as under these conditions the current in the input stage is elevated over its idle value. It should also be noted that connecting a resistor to the upper supply only injects a fixed current and if the upper supply is fixed and well bypassed. If the application includes variable or adjustable supplies, a current source diode could also be used. These two terminal components combine a JFET and resistor connected within the package to behave like a current source.

As a second stability measure, the PA78 is externally compensated and performance can be optimized to the application. Unlike the R_{bias} technique, external phase compensation maintains the low idle current but does affect the large signal response of the amplifier. Refer to the small and large signal response plots as a guide in making the tradeoffs between bandwidth and stability. Due to the unique design of the PA78, two symmetric compensation networks are required. The compensation capacitor C_c must be rated for a working voltage of the full operating supply voltage ($+V_s$ to $-V_s$). NPO capacitors are recommended to maintain the desired level of compensation over temperature.

The PA78 requires an external $33pF$ capacitor between $Cc-$ and $-V_s$ to prevent oscillations in the falling edge of the output. This capacitor should be rated for the full supply voltage ($+V_s$ to $-V_s$).

LARGE SIGNAL PERFORMANCE

As the amplitude of the input signal increases, the internal dynamic current sources increase the operation bandwidth of the amplifier. This unique performance is apparent in its slew rate, pulse response, and large signal performance plots. Recall the previous discussion about the relationships between signal amplitude, supply current, and slew rate. As the amplitude of the input amplitude increases from $1V_{p-p}$ to $15V_{p-p}$, the slew rate increases from $50V/\mu s$ to well over $350V/\mu s$.

Notice the knee in the Rise and Fall times plot, at approximately $6V_{p-p}$ input voltage. Beyond this point the output becomes clipped by the supply rails and the amplifier is no longer operating in a closed loop fashion. The rise and fall times become faster as the dynamic current sources are providing maximum current for slewing. The result of this amplifier architecture is that it slews fast, but allows good control of overshoot for large input signals. This can be seen clearly in the large signal Transient Response plots.

HEATSINKING AND SAFE OPERATING AREA

The MOSFET output stage of the PA78 is not limited by second breakdown considerations as in bipolar output stages. Only thermal considerations of the package and current handling capabilities limit the Safe Operating Area. The SOA plots include power dissipation limitations which are dependent upon case temperature. Keep in mind that the dynamic current sources which drive high slew rates can increase the operating temperature of the amplifier during periods of repeated slewing. The plot of supply current vs. input signal amplitude for a 100 kHz signal provides an indication of the supply current with repeated slewing conditions. This application dependent condition must be considered carefully.

The output stage is self-protected against transient flyback by the parasitic body diodes of the output stage. However, for protection against sustained high energy flyback, external, fast recovery diodes must be used.

CURRENT LIMIT

For proper operation, the current limit resistor, R_{lim} , must be connected as shown in the external connections diagram. For maximum reliability and protection, the largest resistor value should be used. The minimum practical value for R_{lim} is about 120Ω . However, refer to the SOA curves for each package type to assist in selecting the optimum value for R_{lim} in the intended application. Current limit may not protect against short circuit conditions with supply voltages over $200V$.

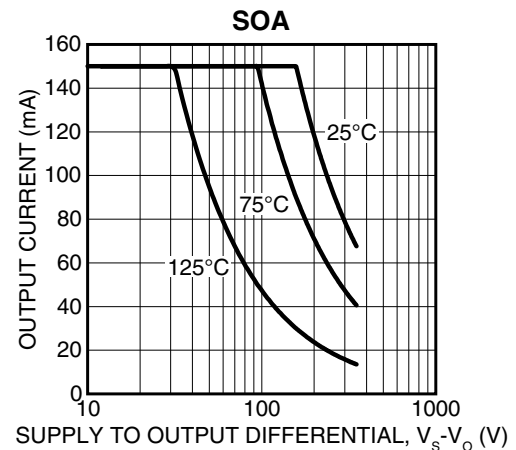

LAYOUT CONSIDERATIONS

The PA78 is built on a dielectrically isolated process and the package tab is therefore not electrically connected to the amplifier. For high speed operation, the package tab should be connected to a stable reference to reduce capacitive coupling between amplifier nodes and the floating tab. It is often convenient to directly connect the tab to GND or one of the supply rails, but an AC connection through a 1uF capacitor to GND is also sufficient if a DC connection is undesirable.

Care should be taken to position the Rc / Cc compensation networks close to the amplifier compensation pins. Long loops in these paths pick up noise and increase the likelihood of LC interactions and oscillations.

SMPS OPERATION

The MP400FC is designed to operate off of a standard voltage rail. Typical values include 12V, 24V, or 48V. The addition of the on-board SMPS eliminates the need to design or purchase a high voltage power supply. The only inputs required by the SMPS are the V_{IN} source. Input and output filter capacitor, and boost voltage set resistor (RSET).

The SMPS output can be adjusted between a minimum of 50V to a maximum of 350V. The voltage boost adjustment is independent of V_{IN} . Adjustment to the boost level is made through a resistor from the RSET pin to ground. The resistor value is:

$$R_{set} = (3.16E6 \cdot (351 - V_{boost})) / (V_{boost} - 1.25) / (4.42E3 - (715 \cdot (351 - V_{boost})) / (V_{boost} - 1.25))$$

Where V_{boost} = desired SMPS voltage.

Example: 1) Desired V_{boost} = 160V
2) R_{set} = 1K (1074 by equation)

If RSET is open, V_{boost} will be 50V. If RSET is shorted to ground V_{boost} will be limited to 350V.

Note that while the MP400 SMPS generates a positive voltage from 50V to 350V, the amplifier may operate from a variety of supply voltages. Symmetric, asymmetrical and single supply configurations can be used so long as the total supply voltage from +Vs to -Vs does not exceed 350V. The amplifier performance graphs in this datasheet include some plots taken with symmetrical supplies, but those plots generally apply to all supply configurations.

SMPS OUTPUT CAPACITOR

An external SMPS output filter capacitor is required for proper operation. ESR considerations prevail in the choice of the output filter capacitor. Select the highest value capacitor that meets the following ESR requirement. The minimum value for C_{BOOST} is 100uF.

$$ESR = dV_o / I_{L_{PK}}$$

Where,

dV_o = the maximum acceptable output ripple voltage

$I_{L_{PK}}$ = Peak inductor current = $(1/L) \cdot V_{in} \cdot t_{on}$

L = 10E-6 if the internal inductor is used.

V_{in} = Input voltage of the application.

t_{on} = $\sqrt{2 \cdot I_o \cdot L \cdot ((V_o + 0.6 - V_{in}) / (F_{sw} \cdot V_{in}^2))}$

V_{boost} = The boost supply voltage of the application.

I_o = The maximum continuous output current for the application.

F_{sw} = 100KHz switching frequency of the MP400FC boost supply.

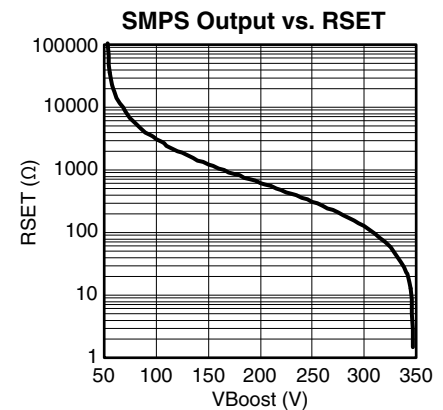

SMPS INPUT CAPACITOR

An external input capacitor is required. This capacitor should be at least 100uF.

THERMAL CONSIDERATIONS

For reliable operation the MP400FC will require a heatsink for most applications. When choosing the heatsink the power dissipation in the op amp and the SMPS MOSFET switch (Q2) are both considered. The power dissipation of the op amp is determined in the same manner as any power op amp. The power dissipation of the MOSFET switch (Q2) is the sum of the power dissipation due to conduction and the switching power.

$$P_{D(Q2)} = (I_{IN(pk)}^2 \cdot R_{DS(ON)} \cdot D) + (I_{IN(pk)} \cdot V_{IN} \cdot t_r \cdot F_{SW})$$

Where:

V_{IN} = SMPS input voltage

V_B = SMPS output voltage

I_O = total SMPS output current

F_{SW} = 100KHz

$R_{DS(ON)}$ = 0.621Ω

t_r = 82 x 10⁻⁹s

D = $t_1 \cdot F_{SW}$

$$t_1 = \sqrt{2 \cdot I_O \cdot 10 \times 10^{-6} \cdot \left(\frac{V_B - V_{IN}}{F_{SW} \cdot V_{IN}^2} \right)}$$

$$I_{IN(pk)} = \frac{V_B \cdot t_d}{10 \times 10^{-6}}$$

$$t_d = t_1 \cdot \left(\frac{V_B}{V_B - V_{IN}} \right) - t_1$$

CONTACTING CIRRUS LOGIC SUPPORT

For all Apex Precision Power product questions and inquiries, call toll free 800-546-2739 in North America.

For inquiries via email, please contact tucson.support@cirrus.com.

International customers can also request support by contacting their local Cirrus Logic Sales Representative.

To find the one nearest to you, go to www.cirrus.com

IMPORTANT NOTICE

Cirrus Logic, Inc. and its subsidiaries ("Cirrus") believe that the information contained in this document is accurate and reliable. However, the information is subject to change without notice and is provided "AS IS" without warranty of any kind (express or implied). Customers are advised to obtain the latest version of relevant information to verify, before placing orders, that information being relied on is current and complete. All products are sold subject to the terms and conditions of sale supplied at the time of order acknowledgment, including those pertaining to warranty, indemnification, and limitation of liability. No responsibility is assumed by Cirrus for the use of this information, including use of this information as the basis for manufacture or sale of any items, or for infringement of patents or other rights of third parties. This document is the property of Cirrus and by furnishing this information, Cirrus grants no license, express or implied under any patents, mask work rights, copyrights, trademarks, trade secrets or other intellectual property rights. Cirrus owns the copyrights associated with the information contained herein and gives consent for copies to be made of the information only for use within your organization with respect to Cirrus integrated circuits or other products of Cirrus. This consent does not extend to other copying such as copying for general distribution, advertising or promotional purposes, or for creating any work for resale.

CERTAIN APPLICATIONS USING SEMICONDUCTOR PRODUCTS MAY INVOLVE POTENTIAL RISKS OF DEATH, PERSONAL INJURY, OR SEVERE PROPERTY OR ENVIRONMENTAL DAMAGE ("CRITICAL APPLICATIONS"). CIRRUS PRODUCTS ARE NOT DESIGNED, AUTHORIZED OR WARRANTED TO BE SUITABLE FOR USE IN PRODUCTS SURGICALLY IMPLANTED INTO THE BODY, AUTOMOTIVE SAFETY OR SECURITY DEVICES, LIFE SUPPORT PRODUCTS OR OTHER CRITICAL APPLICATIONS. INCLUSION OF CIRRUS PRODUCTS IN SUCH APPLICATIONS IS UNDERSTOOD TO BE FULLY AT THE CUSTOMER'S RISK AND CIRRUS DISCLAIMS AND MAKES NO WARRANTY, EXPRESS, STATUTORY OR IMPLIED, INCLUDING THE IMPLIED WARRANTIES OF MERCHANTABILITY AND FITNESS FOR PARTICULAR PURPOSE, WITH REGARD TO ANY CIRRUS PRODUCT THAT IS USED IN SUCH A MANNER. IF THE CUSTOMER OR CUSTOMER'S CUSTOMER USES OR PERMITS THE USE OF CIRRUS PRODUCTS IN CRITICAL APPLICATIONS, CUSTOMER AGREES, BY SUCH USE, TO FULLY INDEMNIFY CIRRUS, ITS OFFICERS, DIRECTORS, EMPLOYEES, DISTRIBUTORS AND OTHER AGENTS FROM ANY AND ALL LIABILITY, INCLUDING ATTORNEYS' FEES AND COSTS, THAT MAY RESULT FROM OR ARISE IN CONNECTION WITH THESE USES.

Cirrus Logic, Cirrus, and the Cirrus Logic logo designs, Apex Precision Power, Apex and the Apex Precision Power logo designs are trademarks of Cirrus Logic, Inc. All other brand and product names in this document may be trademarks or service marks of their respective owners.